



BOURDON
The Original by Baumer



Main Features

- Excellent repeatability
- Dead band adjustment for regulation
- Fix dead band for control and alarm
- Intrinsic safety Hazardous area 0, 1, 2

Applications

- Power generation safety equipment

Technical Data

Temperature range	-46 ... 0 °C to 40 ... 120 °C
Temperature	Process: -46 ... +120 °C Ambient: -30 ... + 55 °C Storage: -40 ... + 55 °C
Repeatability	± 1% F.S. / constant temperature cycle
CE conformity	Low Voltage Directive 2014/35/EU ATEX Directive 2014/34/EU
Protection rating	IP 66 (EN 60529)
Process connection	RTA: Copper alloy RTN: Stainless steel 1.4404 (316L)
Bulb	Stainless steel 1.4435/1.4404 (316L)
Scale	Internal. Accuracy on reading ± 5% F.S.
Cover	Zamak blue painted Captive stainless steel screws
Case	Black Zamak
Mounting	Direct mounting or with wall mounting bracket
Ground connection	Via internal terminal block
Electrical connection	Terminal block with plastic cable gland for Ø 7 to 10.5 mm

Electrical function	See ordering code details on page 5
Adjustment	2 external adjustment screws on top of the case for set point and dead band
ATEX/IECEx	<u>Certificate</u> LCIE 03 ATEX 6123X IECEX LCIE 15.0060X <u>Classification</u> CE Ex I M 1 Ex ia I Ma Ex II 1 G Ex ia IIC T6 or T5 Ga <u>Electrical data</u> U _{max} = 28 Vdc I _{max} = 120 mA P _{max} = 0.84 W C _i = Negligible ; L _i = Negligible

Options

Customer specific set point adjustment	Code SETP
Stainless steel tag plate and wire	Code 9941
Lead seal of the adjustment screws	Code 8990
Nuclear cleanliness (RTN only)	Code 0838
Electrical connection: stainless steel connector (Souriau)	Code 2298
Mobile plug for stainless steel connector (Souriau)	Code 2249

Principle

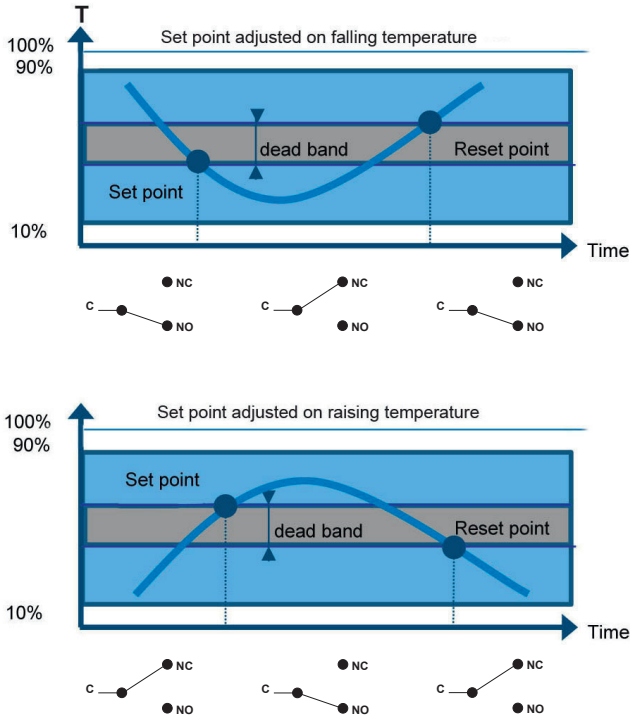

A vapour filled flexible sensing element actuates a microswitch by means of a lever. The set point is adjusted by means of a compressible spring installed in opposition.

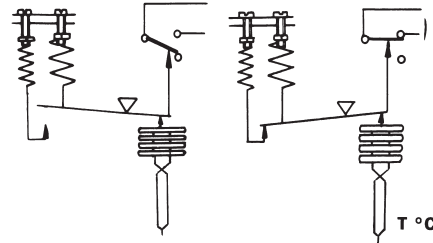

Set point and reset point must be between 10% and 90% of the selected scale.

Standard factory adjustment

Setpoint at 50% of the scale on falling temperature

Customer specific factory adjustment (option SETP)

The following specifications have to be given with the order:

- Setpoint value
- Adjustment on falling or raising temperature
- Dead band value (as needed) when using an adjustable dead band switch

Electrical connections

1 SPDT

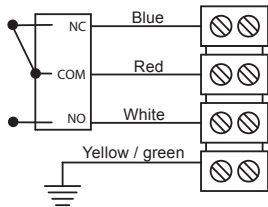

2 SPDT

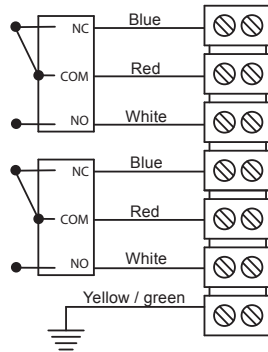

Hazardous area
Zone 0, 1, 2

Certified safety
barrier

Non hazardous
area

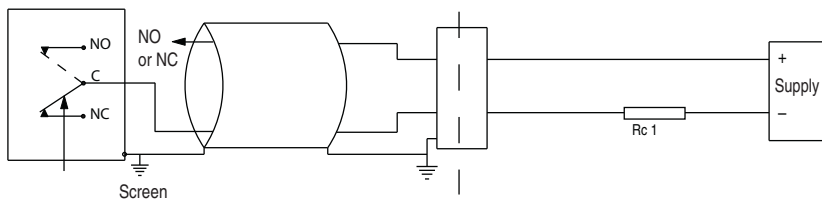

For max. ambient temperature refer to technical data on page 1.

The installation must be made in an intrinsically safe circuit whose certified electrical safety parameters do not exceed any of the values U_{max} , I_{max} and P_{max} given in the electrical data on page 1.

All necessary measures must be taken by the user, to avoid the calorific transfer from the fluid to the apparatus head increasing the head's temperature to such that it reaches the self-ignition temperature of the gas in which it is used.

Micro switches characteristics

Switch code	M (K)	C (W)	S
Type	Gold contact	Hermetic	Ultrasensitive Gold contact
6 Vdc	10 ... 50 mA	5 ... 120 mA	10 ... 50 mA
12 Vdc	10 ... 50 mA	5 ... 120 mA	10 ... 50 mA
24 Vdc	10 ... 50 mA	5 ... 120 mA	10 ... 50 mA
30 Vdc	N/A	N/A	N/A
48 Vdc	N/A	N/A	N/A
110 Vdc	N/A	N/A	N/A
220 Vdc	N/A	N/A	N/A
115 Vac	N/A	N/A	N/A
250 Vac	N/A	N/A	N/A
Dielectric rigidity between contacts and ground	2000 V	1500 V	2000 V

Adjustable ranges

Scale	T _{Max} accidental	Code	Micro-switch dead band ⁽¹⁾					
			Adjustable dead band				Fixed dead band	
			M (K*)		C (W*)		S	
			10%	90%	10%	90%	10%	90%
°C	°C		°C					
-46 ... 0	40	300	4 - 9	2 - 9	8 - 12	4 - 12	3	2.5
-20 ... 20	60	301	3 - 8	1.5 - 8	6 - 12	4 - 12	2.5	1.5
0 ... 45	60	302	4 - 9	2 - 9	7 - 12	4 - 12	3	2
40 ... 120	145	303	5 - 16	3 - 16	10 - 20	6 - 20	4	3.5
20 ... 80	100	315	5 - 12	3 - 12	9 - 15	5 - 15	4	3

(*) For version with 2 microswitches lower values of the dead band must be multiplied x 1.5

⁽¹⁾ The value of the dead band is depending on the value of the set point.

This table contains the dead band values for set point adjustment at 10% and 90% of the selected scale. For adjustable dead band the lower value corresponds to the dead band spring totally released and the higher corresponds to the dead band spring fully tensed. For other set points the dead band value can be calculated by linear interpolation between the values at 10% and 90%.

Dimensions (mm)

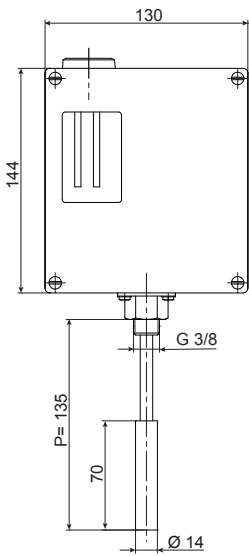
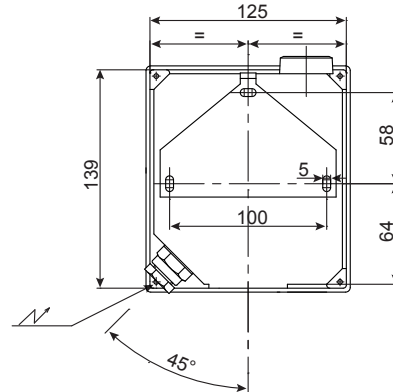
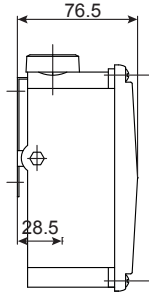
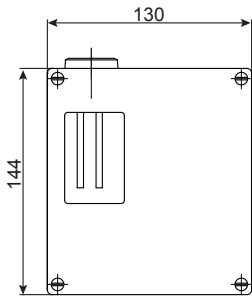

Thermowell
Thermowell for RTxx3
Stainless steel
Ordering code: 10271317

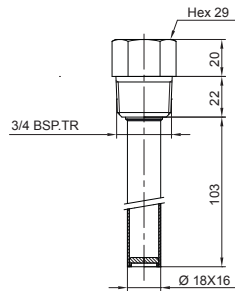

Ordering details RTNY3-RTAY3

	RT	-	Y	.	3xx	.	E	0	0	E	J	/
Model	RT	-										
Industrial temperature switch	RT	-										
Type of the bulb												
Stainless steel bulb + Copper alloy connection			A									
Stainless steel bulb + Connection			N									
Approval												
ATEX/IECEX intrinsic safety			Y									
Type of micro switches												
Deadband												
1 SPDT hermetically changeover switch					Adjustable						C	
2 SPDT hermetically changeover switch					Adjustable						W	
1 SPDT gold contact changeover switch					Adjustable						M	
2 SPDT gold contact changeover switch					Adjustable						K	
1 SPDT ultrasensitive gold contact changeover switch					Fix						S	
Temperature range (°C)												
-46 ... 0					300							
-20 ... 20					301							
0 ... 45					302							
40 ... 120					303							
20 ... 80					315							
Type of design												
Direct mounting (TRD)										E		
Capillary length												
Without capillary										0		
Stem length P												
P=135 mm										0		
Bulb diameter												
Ø 14 mm											E	
Process connection												
G3/8												J

Options to be added behind the / (see example below) /

Ordering example with options

	RT	-	A	Y	C	.	300	.	E	0	0	E	J	/	SETP	_	9941
Industrial temperature switch	RT	-															
Stainless steel bulb + Copper alloy connection			A														
ATEX/IECEX intrinsic safety				Y													
1 SPDT standard changeover switch					C												
Temperature range -46 ... 0 °C						.	300	.									
TRD direct mounting																	
Without capillary																	
Immersion length P=135 mm																	
Bulb diameter Ø 14mm																	
Process connection G3/8																	
Option: Customer specific set point adjustment															SETP	_	
Option: Stainless steel tag plate and wire																	9941